



AGArangeusa.com

48" MERCURY DUAL FUEL RANGE

MODEL: **AMC48DF**



The AGA Mercury range is known for its bold design, contemporary details, zero-clearance facade and mod style cooking controls. It is truly a statement piece in any luxury kitchen.

Designed and built in the UK, this range is a technical masterpiece, the embodiment of exquisite quality and stylish, thoughtful design. Available in 16 sophisticated finish options, The AGA Mercury range is the perfect match for any mood or lifestyle.

SPECIFICATIONS

- Electrical: 240 V 60 Hz
- Electric Rating: 240V (2 Wire + N + Grd), 60Hz, 7.4 kW
- Gas: ½" NPT at rear right-hand side
- Oven Ratings:
 - Fan element (x2): 2.5 kW
 - Top element (x2): 1.2 kW
 - Browning element (x2): 1.15 kW
 - Bottom element (x2): 1.0 kW
- Product Dimensions: 47 9/16" W x 28 7/16" D x 36 7/32" H
- Shipping weight (lbs): 390 lbs (includes range, crate & pallet)

WARRANTY

- 2 Year Warranty on parts and labor with exception of cosmetic parts & lightbulbs

FINISHES

NOTE: Colors not in stock could have a 4-12 week lead time (check for availability). Ranges manufactured using Soho colors are only available with stainless steel fascia.

CLASSIC COLOR COLLECTION

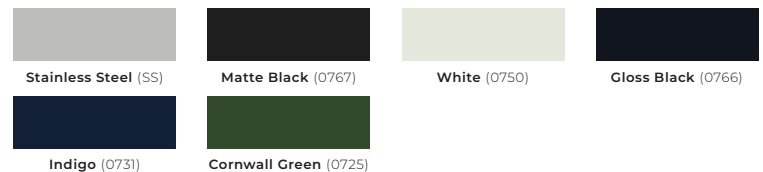

SOHO COLOR COLLECTION



OPTIONAL KNOB FINISH

NOTE: The AGA Mercury ships standard with Stainless Steel Knobs, but also has a Black finish option available as an after-market purchase.

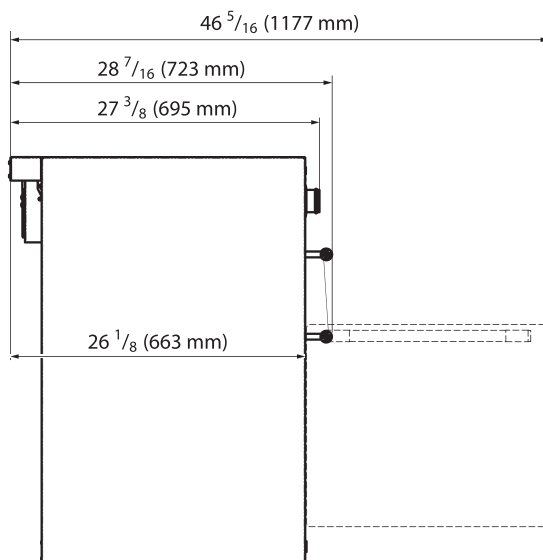
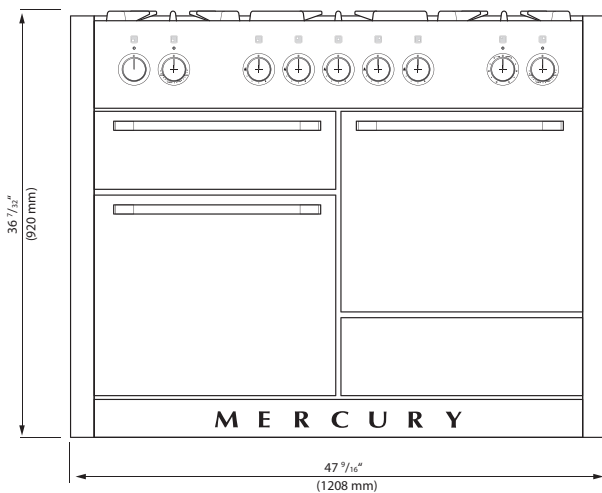

Oven Dimensions: 18 ½" W x 16" D x 16" H



48" MERCURY DUAL FUEL RANGE

5 BURNER COOKTOP

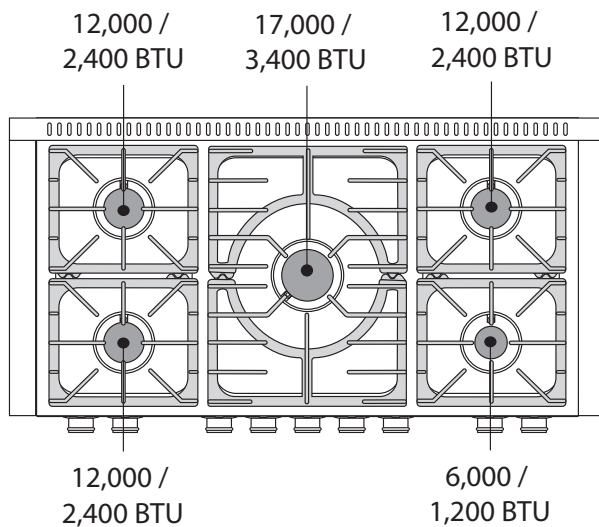

FEATURES

- 9 Hi-Fi Style Infinite Controls turn with stereo-like grace
- Powerful 8-pass, 2300 watt Broiling Oven - ready in 5 minutes
- Glide-out Broiler System with adjustable heights and extendable gliding tray spacious enough to cook six 6-oz steaks at once
- 5 sealed brass burners; one 17,000 BTU, three 12,000 BTU, one 6,000 BTU, with continuous cast iron grates easily slide pots and pans from burner to burner without spilling. All burners designed with thermocouple safety mechanism.
- 6 interlocking enamel finish cast iron grates x LP Conversion Kit included
- One extra-large 7-Mode Multifunction Convection Oven, one true European Convection Oven, Fan-Assisted Baking, Browning, Thaw-to-Serve, Convection Broiling, and Warming
- Over 6 cubic feet of oven space amongst 3 separate ovens maximize utility and reduce energy consumption
- The multifunction oven features 3 heavy-duty stainless steel shelves including a removable Telescopic shelf, while the second oven features 2 heavy-duty stainless steel shelves
- Easy clean technology with black vitreous enamel interior

7 MULTIFUNCTION COOKING MODES

